

December 2022

Electrical

Products & Solutions™

The Purchasing Guide for Electrical Contractors

www.epsmag.net



**INDUSTRY
NEWS**

CORDLESS CANNON 6K

iTOOLco.

WWW.iTOOLco.com | 865.670.3713



Speed, versatility, and performance are all yours with iTOOLco's Cordless Cannon 6K™. This portable 6,000 lb. puller is intuitively designed to handle all of your day-to-day wire pulls.

The built-in capstan switch automatically turns the puller on and off. Simply tug on the rope to start the pull and slack off the rope to shut it down. Delivers dynamic performance in remote locations or areas where power is not yet available.



LIGHT WORK DAY.

TCP makes it **EASY** to plan your lighting design project.

**GET A QUOTE
GET A GIFT**

Visit TCPi.com or
call 888.399.4217

INNOVATION IS LED BY TCP



TOP PRODUCTS

8 This year's Top Products in the Electrical Industry Market

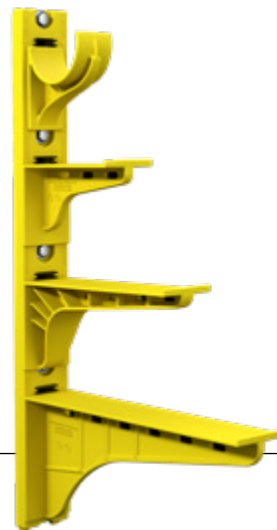

DEPARTMENTS

- 24 INDUSTRY NEWS
- 32 AD INDEX

Electrical Products & Solutions

PUBLISHER
Danny J. Salchert

OFFICE MANAGER
Anita Salchert

CREATIVE DIRECTOR
Derek Gaylard

CIRCULATION DIRECTOR
Pam Fulmer



PRESIDENT
Danny J. Salchert

EXECUTIVE AND ADVERTISING OFFICES
2009 Eagle Ridge Drive
Birmingham, AL 35242
phone: 205.981.4541
www.epsmag.net
danny@epsmag.net

Electrical Products & Solutions™ is published twelve times a year on a monthly basis by ABD Communications, Inc., 3591 Cahaba Beach Road, Birmingham, Alabama, 35242, USA. Electrical Products & Solutions™ is distributed free to qualified subscribers. Non-qualified subscription rates are \$57.00 per year in the U.S. and Canada and \$84.00 per year for foreign subscribers (surface mail). U.S. Postage paid at Birmingham, Alabama and additional mailing offices. Electrical Products & Solutions™ is distributed to qualified readers in the electrical contracting industry. Publisher is not liable for all content (including editorial and illustrations provided by advertisers) of advertisements published and does not accept responsibility for any claims made against the publisher. It is the advertiser's or agency's responsibility to obtain appropriate releases on any item or individuals pictured in an advertisement. Reproduction of this magazine in whole or in part is prohibited without prior written permission from the publisher.

POSTMASTER: Send address changes to ABD Communications, Inc., P.O. Box 382885 Birmingham, Alabama 35238-2885

FOLLOW US ON



We're Proud to be the Electricians' Friend for Over 50 Years!

Qwik Duct Safer Better Faster

HDPE CUSTOM TEMPLATES In Any Configuration Required

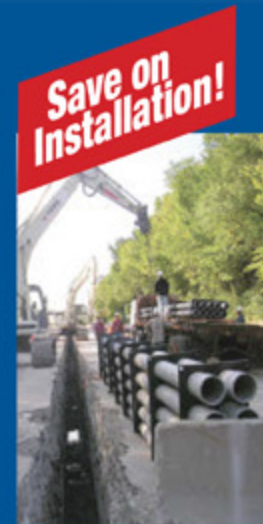

Save on Installation!



Patent Pending

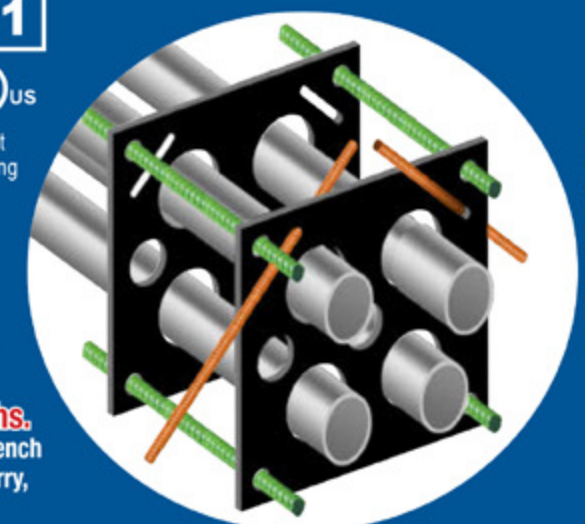

Patent Pending



PVC Offset

Sizes 1/2" thru 6" Meets Flexible Mandrel Test Requirements

Bore Spacers

Sizes 1/2" thru 6" Roll assembled conduit into caissons and under obstructions



Conduit Transition Couplings



End Bell Adapter Schedule 40/80 PVC



PVC/PVC



PVC/EMT



PVC/Rigid

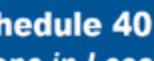

PVC/Liquidtite



PVC/Stainless



PVC/Alum



PVC/Flex



IP14a

Save Cost on the Rigid Nipple, Tape & Labor Use for Entire Job - Not Just for Repair

1 Piece Reaming Bit 1/2" thru 6" Schedule 40/80

Plus More Being Invented for SAFER BETTER FASTER Jobs... Call With Your Ideas!



SPProducts.com 800-233-8595 info@SPProducts.com

REPAIR CONDUIT IN A SNAP!

No Tape • No Plastic Straps • No Metallic Straps

NO KIDDING!

Designed especially for power, communications and fiber optics.



“The World Leader In Split Conduit Products”



 **Conduit Repair Systems, Inc.**
The World Leader In Split Conduit Products



800.670.1804 • 435.673.8724 fax • crs@conduitrepair.com • www.conduitrepair.com

- + Rise Higher
- + Go Farther
- + Shine Brighter
- + Work Smarter

The New 100W OmniMax



More light. Dependably beautiful.
With light output competitive to a 150W HID, you get more lumens, across a broader range of applications, without compromising light quality.

You asked, and we delivered. The 100W OmniMax LED retrofit was designed specifically for applications where you need more light from your decorative fixtures, such as taller pendant and teardrop applications (>25'), and locations where decorative luminaires are the primary light source.

A new patented Evluma driver delivers higher lumen output, even at lower CCT levels. Pair that with OmniMax's revolutionary low-glare optics, and you get the kind of light your decorative fixtures were built for: warm, beautiful and bright.

evluma

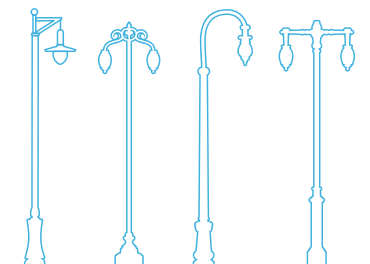

Protect Yourself

Miller Safety Consultants — A Leader in Arc Flash Protection

Vince Miller started Miller Safety Consultants, a veteran owned business in 1999. The goal of the business was to provide cost effective safety consulting, employee training such as: confined space entry, fall protection, electrical safety and provide sales of electrical shock and flash protective equipment and fall protection equipment to businesses in the Washington DC area.

Reliance Industries provided fall protection products and much of the sales and training was on behalf of the supplier. In 2000, the owner decided to retire from his business, and Vince decided to discontinue the fall protection line of his business and concentrate more in the electrical training and products.

Vince had been a distributor for Certified Insulated Products (CIP), a manufacturer of electrical insulated tools and electrical arc flash clothing manufactured by Otex in Rochester, New York. As a distributor, Vince provided sales through his internet website and much through relationships with electrical contractors. His training was a classroom environment and was provided directly to customers but he also taught as a sub-contractor

for other safety consulting companies and the Chesapeake Safety Council in Baltimore, Maryland. In 2005, Vince partnered with Vivid Learning Systems in Cascades, Washington to provide on-line training in safe work practices.

Training in electrical safe work practices is still provided locally in the Washington DC area and as a partner with an electrical engineering firm and online. The training is based on the Occupational Health and Safety Administration (OSHA) standards and the National Fire Protection Association (NFPA) 70E standard.

Miller Safety Consultants is now a distributor for Cementex USA, Burlington, New Jersey, for insulated tools and equipment and clothing from OTEX Protective, Rochester, New York.

The majority of his sales of products

are from the web-based store. Cementex is nationally known for their quality equipment. Otex Protective is becoming more known for their quality clothing. For years, they have manufactured their products under other provider labels. Vince chose to not create his clothing line, but to sell the manufacturer product.

Vince has worked with many electrical company employees to fine-tune the clothing to be more comfortable for the user. Working closely with the manufacturer, they have made slight changes in how the cloth pattern was modified to meet final production. An example is the lightweight 40 Calorie vented hood offered by Otex.

The material is of the latest technology. The vented assembly is constructed for balance on the back of the hardhat and the airflow is 27 CFM to prevent fogging of the face shield and provide cooling to the worker. It took over a year to develop the product with the user prior to having the hood "flash tested". This product is now standard issue with many electrical contractors.

Being a small business and having quality providers has resulted in satisfied customers for Miller Safety Consultants. Being a direct supplier for OTEX Protective, another small business means customized customer needs can be met. □

For more information, visit
Miller Safety Consultants at:
www.electricalsafety.com, email
Vince at: sales@millersafetyltd.com.

AUTHORIZED
Cementex
The Safety Tool Specialists
DISTRIBUTOR

Give Vince a call at
(703) 367-0404



Deluxe Maintenance Tool Kit



Class O Glove Kit

Protect yourself from "Arc Flash"

ARC FLASH LIFT-FRONT HOOD WITH V¹² HIGH-VOLUME VENTILATOR
Compact. Powerful. Reliable

Our V¹² High-Volume Ventilator boasts an unexpectedly quiet, high output (35+ CFM) turbine fan to cool and circulate the ambient air within the hood. Fully protected beneath it's durable ABS shell and added fabric layering, the V¹² High-Volume Ventilator isn't just compliant, it's superior.



40 CAL/CM2 ULTRALIGHT CLOTHING BY OTEX

Our new dual-layer Ultralight clothing takes advantage of DuPont's® dedication to scientific advancement and Westex's® industry leading dependability. Weighing in 37% lighter than traditional HRC4 PPE, our Ultralight Clothing is the most innovative contender in the lightweight arena.

HYBRID LAYERING

Combined Fabric Weight: 14 oz

Outer Layer: DuPont® Protera
Color: Navy

Inner Layer: Westex Ultrasoft
Color: Safety Orange



CALL US TODAY
(703) 367-0404

OR VISIT OUR ONLINE ELECTRICAL SAFETY EQUIPMENT STORE
www.electricalsafety.com

Each year we choose what we believe are **Top Products** in the Electrical Industry market. This year is no different. The products and services chosen are each unique, beneficial and reliable in their own right. Having the ability to choose the tools and services that best fits your job description and your work style is what it's all about. We hope you agree with our choices.



American Conduit's PullEase™

PullEase™ aluminum EMT is a patented design tested to reduce internal resistance when pulling wire. No messy lubrication required, just easier wire pulling and overall labor savings with lightweight aluminum. Make the change with an easy-to-pull and easy-to-carry lightweight aluminum alternative!

Ask your stocking distributor about PullEase today.

For more information, visit www.AmericanConduit.com



Innovative Two-Piece Split Conduit and Split Coupler System

As the world leader in split conduit repair products, Conduit Repair Systems' provides an array of products to offer you the perfect solution for your repair needs. Conduit Repair Systems' innovative two-piece split conduit and split coupler system is available in ten-foot split conduit lengths, pre-bundled repair kits, split WYE kits, and our industry leading split sweeps.

Conduit Repair Systems' split sweeps are available in a 24" or 36" radius and come in both 45° and 90° sweeps. They are great for electrical conduit applications underground, being encased in concrete, as risers coming up and out of the ground, for solar projects and more. All of our split sweeps are available in the following sizes: 1", 1.25", 1.5", 2", 2.5", 3", 4", 5", and 6".

With our two-piece split conduit system, no tape, straps or clamps are needed. Everything is done in a snap!

For more information, visit www.conduitrepair.com





Appleton™ Mercmaster™ Connect LED Luminaire

The Appleton™ Mercmaster™ Connect LED Luminaire by Emerson is designed to illuminate hazardous and harsh industrial locations with integrated motion and illuminance sensors. This groundbreaking solution dramatically lowers cost when compared to wired monitoring alternatives, with faster installation time and minimal disruption to plant operations.

Mercmaster Connect LED Luminaires are linked wirelessly to Plantweb Insight™ software via Emerson WirelessHART™ network technology. With quick and accurate data analysis made possible by Plantweb Insight, it is much easier to prioritize maintenance and identify potential hazards or failures that may put the safety, reliability, and compliance of a facility at risk.

For more information, visit www.appleton.emerson.com

RX1 RoadMax Roadway Luminaire

RoadMax combines precision roadway performance with industry-leading glare control. Meet RP-8 guidelines and maintain exceptional pole spacing. Options and features include Type II, Type III and Type V distributions, field adjustable wattage selector, light trespass shields, and 20kV/10kA surge protection. Customize to include Evluma's Photocontrol Failsafe or ConnectLED, Evluma's Bluetooth app for wireless lighting controls, enables dimming and dimming schedules without the need for a network.

The RoadMax roadway series will include three sizes designed to replace legacy HID 100w, 250w and 400w cobraheads. RoadMax RX1, with wattages ranging 30W-70W and a 3,000 to 9,000 lumen output is available now.

For more information, visit evluma.com



DRIVEN TO DELIVER

THE CONSOLE X



• Clean up those cabs and get your fleet organized!

Your Total Mobile Office Solution

The Truck Console -X combines your Laptop Work Station, Radios, Speakers, Cables, Storage and Cup Holders. No Drill Installation Brackets Included.

The **Truck Console -X** is the latest innovative mobile office solution to join the Mobile Desk brand family of products. This complete control, communication and convenience Utility Truck Console is becoming the new standard for fleets of all sizes. The design of the **Truck Console -X** has originated from our years of experience working directly with the lineman, supervisors, communications, and fleets of some of the most notable utility companies in America. Loaded with standard and optional features that maximize ergonomics, productivity, and fleet/telecom standards into one Mobile Office Solution.

Screen Out™ SCREEN-DISABLER™

Blanks your screen while you drive!
Our Patented Screen Out App **Stops texting** while driving for all employees on all tablets, laptops and smart phones that run Windows, iOS or Android Operating Systems. *It's that easy!*
877-663-3375 Ext 303. www.screenout.net

Find us on:



1-877-663-3375

www.mobiledesk.com

©2018 Mobiledesk

Greaves SNAP! Makes Perfect Connections

SNAP! connectors offer time-saving convenience, and the ability to work in tight spaces without bulky tools and dies. Insert your stripped wire, then turn a standard (box or adjustable) wrench to compress the copper body until the pre-calibrated nut snaps off. The result is superior conductivity and pull-out strength. SNAP! Connectors are UL listed. I got tired of hauling around a heavy hydraulic crimper and a full set of dies just to do 3 or 4 simple connections. For inspection, the slots show that the wire is fully inserted. When the connection is completed, the hex nut is gone, showing that the connection is complete and solid. After insulation (cold-shrink, heat-shrink, tape, etc.) the resulting shape without the hex nut is visually apparent. SNAP+ kits include cold-shrink sleeves. SNAP! is available in 1-hole and 2-hole NEMA lugs, and splices, for #2 through 500MCM.

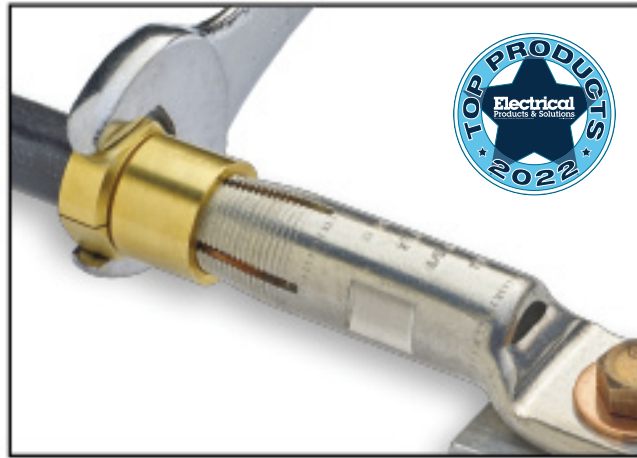

For more information, visit www.greaves-usa.com

iTOOLco's 20,000 LB. Rated Hydraulic MVP20K

iTOOLco's 20,000 LB. rated hydraulic MVP20K is sure to meet any challenge. The fully self-contained unit attaches to any high flow skid steer, providing long awaited jobsite mobility.

iTOOLco's industry leading dual capstan design and overall jobsite versatility afford operators many different setup configurations. Hydraulic booms ensure an easy set up and placement, increasing pulling efficiency. The MVP20K features an adjustable output torque limit dial, allowing the user to set load limits prior to the pull. Ensuring the puller never exceeds the preset limit by shutting the capstans off when the max load is reached. With staggering pulling speeds reaching up to 65' per minute under load, the MVP20K is the most advanced pulling system on the market today. An easy to read force gauge and optional running line tensioner make quick work of monitoring and recording pulling tensions.

For more information, visit www.iTOOLco.com



iTOOLco's Strut Driver

Safely drive your strut from ground level with iTOOLco's Strut Driver. The Strut Driver eliminates the need for climbing up ladders and using sledge hammers to drive strut into the ground. With both feet planted on the ground, plug the Strut Driver into your SDS MAX hammer drill. Then ensure the hammer drill is in hammer mode and drive it home. The unique engagement teeth allow users to drive strut sizes ranging from 1/2" to 1-5/8" from the side. Simply insert the engagement teeth into the strut, then drive.

Once the strut is driven in far enough, move to the top of the strut to finish driving it to the final grade level. Note: The end receiver is designed to accept 1-5/8" size strut & up to 3/4" size rod. You can use the engagement teeth to sink other sizes below grade.

For more information, visit www.iTOOLco.com



Lighting Your Way at Greater Heights

The Appleton™ IHC LED Luminaire by Emerson is the ideal solution to deliver light from mounting heights of 50 to over 100 feet. With outputs up to 90,000 lumens, an IP66 marine and wet location rating, and an ambient temperature range of -40 °C (-40 °F) to 75 °C (167 °F), the IHC was designed to meet the demands of your harsh industrial environment and lighting requirements.

Learn more at: masteringled.com

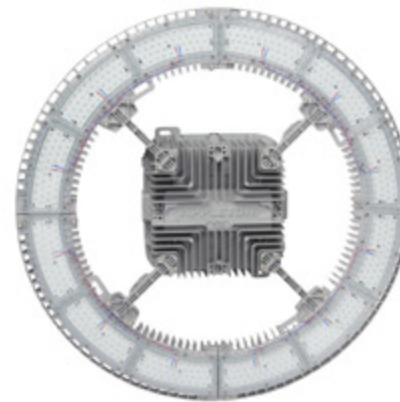

Appleton™ IHC LED Luminaire

APPLETON™

The Emerson logo is a trademark and a service mark of Emerson Electric Co. © 2021 Emerson Electric Co.



CONSIDER IT SOLVED™



New UltraLite 40 Cal Lift-front Vented Hood

We've listened to our users who perform "non-contact" testing within the arc-flash protection boundary and have release the OTEX lift shield hood. This new style hood will incorporate the Paulson lift shield assembly. The new hood assembly will also have the additional safety features of our standard M12 vented 40 Cal hood such as the patented arc flash sensor, head lamp and the Milwaukee M12 battery powered fan system.

For more information, visit
www.electricalsafety.com

The Console-X

Console-X Truck Consoles from Mobile Desk / Mobile Office Solutions has become the new standard for Electric Utility Contractors and Companies of all sizes. The rapid adoption of the Console-X within the Electric utility markets has driven by its unique ability to consolidate Fleet, Telecom and End Users standards and requirements into a single package.

Compatibility:

Its rugged design accommodates any environment for the most popular trucks utilized in the electric utility industry including the following vehicles 2008 -2020 Ford F-150- F-550 / 2009-2020 Chevy Silverado 1500-5500 / 2005-2019 Dodge Ram 1500-550 / International 4000 and 7000 series / 2003- 2020 Freightliner M2 and Cascadia and most Peterbilt and Kenworth Semi Tractors.

Features and Options

Include, Large full or partial storage, file rails, integrated or magnetic cupholders, ergonomic and secure laptop and tablet mounting, adjustable single or dual armrests, power distribution, ring terminal block, map box, radio slot, dual or single buss electronic timers, no-drill installation, magnetic mic clip, switches, wiring harness, quick disconnects, 400 and 600 watt pure sine power inverter with ignition sense relay, office supply tray, magnetic phone mounts, pre-wiring and fused PDU optional, Lind Laptop and Tablet power solutions. Dual 3.1 amp USB and properly used 12-volt accessory ports.

In the previous ten years, no other vehicle accessory has had more impact in the Electric Utility Industry than the Console-X.



For more information, visit
www.mobiledesk.com



Extend Luminaire Life While Reducing Energy Consumption

The Appleton™ Mercmaster™ Connect LED by Emerson is designed to illuminate hazardous and harsh industrial locations with integrated motion and illuminance sensors. Paired with Emerson's Plantweb Insight Connected Lighting Application, operators have access to lighting usage data and sustainability analytics.



Appleton™ Mercmaster™ Connect LED

The Mercmaster Connect LED provides facility managers with continuous monitoring of their LED lighting with real-time insights gained into sustainability goals, diagnostics and lumen levels from any remote location at dramatically lower costs as compared to wired alternatives, with faster installation time and minimal disruption to plant operations.

Learn more at: masteringled.com

APPLETON

The Appleton logo is a trademark and a service mark of Emerson Electric Co. © 2021 Emerson Electric Co.

EMERSON

CONSIDER IT SOLVED™

Model 15KVSet Voltage Probes

Summit Technology's model 15KVSet voltage probes allow connecting PowerSight power analyzers directly to 3-phase voltages up to 15 kilovolts. Normally, professionals who wish to measure 12,470 volt lines need to locate or install a PT (potential transformer) in order to monitor medium voltages. The 15KVSet allows direct connection of medium voltages to PowerSight analyzers. Shown with optional hot sticks, the 15KVP has shepherd hooks for hanging on bare cable, taping or bolting to bus bar, or any other connection that is needed. The 15KVSet comes disassembled in its own compact canvas carrying case. The probes may be purchased singly and with or without hot sticks. For 4160V motors, we recommend the more compact 5KVP. These voltage probes must be used with the PowerSight® line of Power Analyzers, manufactured by Summit Technology Inc.



For more information, visit
<https://powersight.com/products/voltage-probes/5KVP/>



**Install Peace of Mind! First there was 4 square...
And now the REVOLUTIONARY
5 Square Box!**

You've struggled with 4 Square boxes for years - you know how small, cramped and time consuming they are. Finally, there is a solution that allows you the space you have always needed. The 5 Square® Boxes (5" x 5" x 2-7/8") provide up to 88 in³ of interior volume which more than doubles that of most existing boxes on the market. Create a robust and unrivaled infrastructure for the life of your facility with the 5 Square® Products!



For more information, visit
www.randl-inc.com

Series 4+ Manual Transfer Switch

Ronk's line of trusted and durable manual, automatic, double throw and disconnect switches are reliable and available with shorter than average lead times. It is crucial to have your power systems working to the best of their ability, and to easily be able to transfer loads when power continuity is critical. With Ronks Series 4+ Manual Transfer Switch, you will have a dependable unit for decades to come, with a fast and secure way to transfer loads between your main power and an auxiliary power source. Our Series 4+ Manual Transfer Switches are available in different amperages and are all UL listed. With an ever-growing need for emergency backup power systems in hospitals, healthcare facilities, data centers, commercial buildings, and other public facilities, it is critical to have transfer switches that ensure authenticity and safety – inquire about Rock's transfer switches today!



For more information, visit
www.ronkelectrical.com



Versatile Mounting for Extreme Environments

The SolaHD™ SCP-X Series Standalone IP67 Power Supplies by Emerson can be mounted almost anywhere on a machine, conveyor, or wall. With no enclosure required they offer safety against arc flash hazards.



SolaHD™ SCP-X Series Standalone IP67 Power Supplies

Quick-connect cables ensure the IP67 rating and eliminate costly wiring. Available from 100 Watts to 240 Watts, the SCP-X Power Supplies meet the diverse needs of automotive manufacturing, conveyor systems, and equipment where 24 Vdc power is required for geographically dispersed devices.

Learn More at: www.solahd.com

SOLAHD™

The Emerson logo is a trademark and a service mark of Emerson Electric Co. © 2021 Emerson Electric Co.



CONSIDER IT SOLVED™

Transition Couplings PVC Bell End Adapter to Galvanized Rigid Conduit

Faster way to transition from a PVC SCH40/80 conduit Bell end side to Galvanized rigid elbow without reaming PVC conduit. Just screw and glue and you're done quickly connecting PVC to rigid. Insert into bell end of PVC conduit, apply PVC cement glue and thread into galvanized rigid coupling on the rigid elbow. C UL US Listed and Made in USA.



For more information, visit www.spproducts.com

PVC Driver for Joining PVC SCh40 Conduits in a Prefab Setting

PVC Driver Catalog numbers
Catalog number PVCD-100-125-150. 1 thru 1.50 inch sizes
PVCD-200-250-300. 2 thru 3 inch sizes
PVCD 350-400. 3.50 thru 4 inch sizes
PVCD 500 5 inch size
PVCD 600 6 inch size
PVCD 800 8 inch size

Assemble PVC conduits on a duct bank lighting fast in a prefab setting or by trench side using PVC Driver with a power hammer drill. Lightweight, made of aluminum. Multiple sizes on one tool allows ease of use by eliminating changing different sizes. Just hammer drill PVC Driver entering the proper size conduit id and push it to join 2 pieces of 10 ft Pvc conduit in a matter of seconds. Safer to use because is lightweight. Each prefab shop must use this tool for safer, faster, better jobs. Made in USA.

For more information, visit www.spproducts.com

Box and Conduit Support Plate CSP 28x28 Supports up to 20"x20" Junction Box

Mount Box Horizontally or vertically from a single support
Bend down tabs at centers of outer edges to accept up thru 1/2" rod for vertical installation.
Drill hole in center of back of box to allow attaching single support through open cross on 28x28 plate to mount horizontally.
4 open KO's in center of plate allow conduit or MC cable to enter and leave back of box. Load rating of conduit and box support plates is associated with load rating of box and mounting hardware.
1/4" slot and tek screw holes are provided to install clamps at any direction.
Made of 16 gauge galvanized steel.
Made in USA
C UL US Listed



For more information, visit www.spproducts.com

Productivity and value thru ideas
FOR SAFER BETTER FASTER JOBS

We're Proud to be the Electricians' Friend for Over 50 Years!

**IP15a
Chamfer Bit
for PVC SCH 40/80**

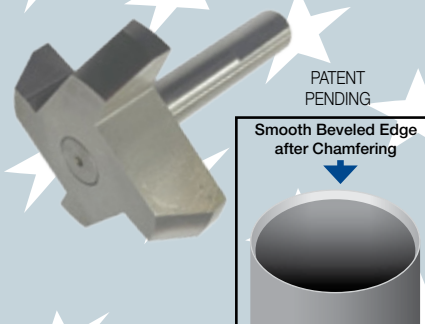

**IP27b
Electro Post EP-10
Box Support Bracket**

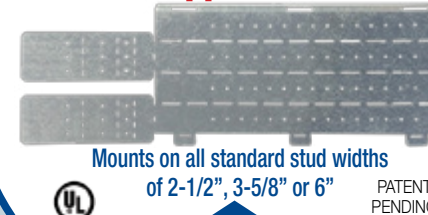

**IP15b
Chamfer Bit
for Aluminum EMT**

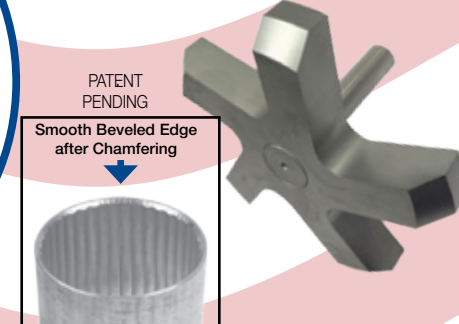

**NEW
PRODUCTS**

**4-WAY
CONDUIT & BOX
SUPPORT PLATE
with Split Fingers
for Horizontal or
Vertical Installation**

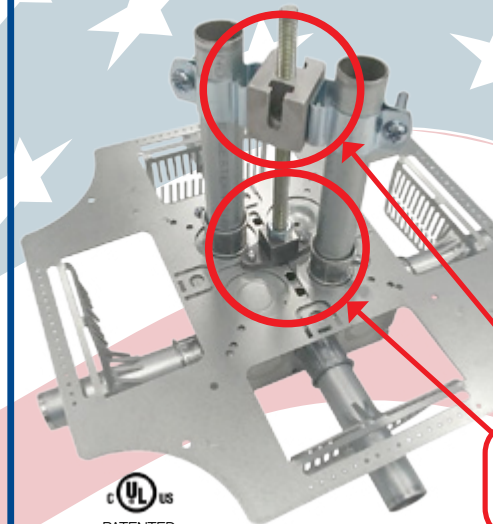

Use 4-Conduit Block (IP19 or IP20) with QwikBlock (IP21a)

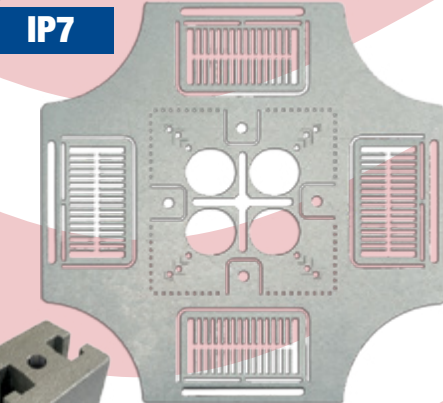

**IP21a
QwikBlock
PATENT PENDING**

**IP19/20
4-Conduit Block
PATENTED**

**PVC Running
Thread SCH 40/80
Up to 30" Long**

IP3d



**NEW Transition Fittings
Saves a Great Deal of Time Repairing Conduit
The Inside Diameter Remains the Same
Allows for Trouble Free Wire and Cable Pulls**

**IP13k
Inside PVC to
Inside PVC
PATENT PENDING**

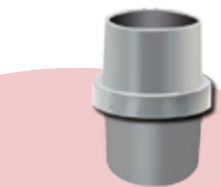

**IP13p
3/4" MC Cable
to PVC
PATENT PENDING**



**IP13q
PVC
Reducer
PATENT PENDING**



**Male Threaded
PVC Offset**

IP3c

1/2" thru 3" Offset for Conduit Sizes 1/2" thru 6"

PATENT PENDING



Plus More Being Invented for SAFER BETTER FASTER Jobs . . . Call With Your Ideas!

EASIER TO PULL • EASIER TO CARRY!

PullEase™ aluminum EMT

Low friction & lightweight
From the aluminum experts at Hydro!



AMERICAN CONDUIT



www.AmericanConduit.com

200 Riviera Blvd, St. Augustine, FL 32086
Phone: 800-334-6825



Compact and Easy to Install DC UPS for Harsh Industrial Locations

The SolaHD™ SDU DC - B Series DIN Rail UPS by Emerson are perfect for mitigating power quality issues, minimizing loss of data and downtime.



SolaHD™ SDU DC - B Series DIN Rail UPS

The SDU DC - B UPS combines an industry leading compact design, wide operation temperature range -15 °C to +50 °C (+5 °F to +122 °F), enhanced communication and unique installation options to solve common application problems.

Learn more at: www.solahd.com

SOLAHD™

The Emerson logo is a trademark and a service mark of Emerson Electric Co. © 2021 Emerson Electric Co.



CONSIDER IT SOLVED™



High Lumen LED Filament Lamp

TCP's energy-efficient High Lumen LED Filament Lamps are the ideal replacements for HID metal halide lamps and corn cob lamps. The classic HID shape fits perfectly into existing fixtures. Bypass application means that no cumbersome ballasts are needed for operation. Its smaller design makes it extremely versatile in that it simply screws into existing sockets and fits in open or enclosed fixtures. Not to mention, these bulbs weigh significantly less than their bulky corn cob alternatives - making installation uncomplicated and safer than ever.



**For more information, visit
TCPi.com**

LED Pro Line Panel

TCP's LED Pro Line Panel luminaire features back-lit technology with a robust construction that offers a slim, low profile with beautiful full-panel diffusion and superior uniformity. The preinstalled TCP Quick Connect wiring allows for quick and easy installation for electrical contractors. With this simple, two-step wiring system, install time is reduced by nearly 75%! These energy efficient luminaires offer a cost-effective solution to maximize energy savings and are eligible for utility rebates. TCP's LED Pro Line Panel luminaires are perfect for offices, schools, retail stores, hospitals, and so many other applications.

**For more information, visit
TCPi.com**



Duct Spacers and Nonmetallic Cable Supports

Underground Devices manufactures several different styles of duct spacers and nonmetallic cable supports. The Heavy Duty Nonmetallic Cable Rack has become a standard in manhole racking. The Heavy Duty Rack is nonconductive and will never rust or corrode. Grounding and insulators are no longer necessary. The Heavy Duty Rack has the same loading capacity as comparable steel cable racks. With seven standard stanchion lengths ranging from 8" to 48" long, and ten arms ranging from a 3" saddle to a 20" long arm, the Heavy Duty Rack is an extremely versatile cable racking system.

**For more information, visit
www.udevices.com**

ALWAYS AVAILABLE

The Top Products issue of *Electrical Products & Solutions* magazine is available year-round and archived for reference just like all of the previous issues at www.epsmag.net.

Redefine roadway performance

Introducing RoadMax. Evluma's next generation roadway luminaires deliver uncompromising performance and industry leading glare control. Because essential roads deserve exceptional light.

Join us at the 2022 IES Street & Area Lighting Conference Dallas, TX, Oct 10-13th

RoadMax[™]
by **evluma**

evluma.com | sales@evluma.com

NSI Industries Names Tom O’Gara First Sales Manager for Company’s Cable & Conduit Fittings Product Category

The New Role Represents an Increased Focus on NSI’s Market Leading Electrical Division Cable & Conduit Fittings Line

NSI Industries, LLC, a leading provider of electrical, HVAC, and building technology product solutions for more than 45 years, is proud to announce it has named industry veteran Tom O’Gara the company’s first national sales manager for its Electrical Division Cable and Conduit Fittings Product category. Previously, O’Gara has been with the company’s Remke brand for the past 15 years, most recently as vice president of sales and marketing.



“Since 2019, NSI has gone through a period of tremendous growth, including our Cable and Conduit Fittings Product category,” said Joe Saganowich, NSI’s Electrical Division President. “This new leadership represents a focus on this category, positioning the Remke and Bridgeport Fittings lines as leading brands in the industry. Tom’s intimate knowledge of these lines makes him the perfect candidate for the category’s national sales manager, which will further strengthen our footprint in these markets.”

In his new role, O’Gara will report directly to Tom Wallace, NSI vice president of sales and will be collaborating with regional vice presidents, the national accounts team, and regional sales managers to support

the company’s strategic initiatives related to NSI’s Cable and Conduit fittings products.

“Tom brings a great deal of sales and product knowledge to our team from his previous roles as Director and Vice President of Sales & Marketing for Remke,” said Wallace. “Remke and Bridgeport now bring a complete cable and conduit fittings solutions package serving our electrical distribution customers end-to-end, and Tom and his team will elevate this category to a new level with an even better customer

service experience.”

NSI’s Cable and Conduit Fittings Product category includes die cast fittings for residential and commercial applications to machined fittings for industrial and OEM applications readily available to ship driven by a large U.S.-based engineering team with custom design capabilities; innovative solutions designed to meet the demands of electricians in fast growth markets including solar, data center, prefab, and food service; backed by NSI’s outstanding service levels and customer service support - one order, one invoice, model designed for stock and flow products.

“During my time with Remke, and since Remke has become a key part of the NSI brand portfolio, we have provided a partnership-focused professional technical sales team and agent network motivated to generate demand in the market,” said O’Gara. “Now, in my new position, we will be even better equipped to care for our customers by streamlining both external and internal processes across multiple departments.”

For more information on NSI, please visit www.nsiindustries.com. □

ABOUT NSI INDUSTRIES, LLC

NSI’s core philosophy is Making Connections. Focused on the electrical, building technology, and HVAC markets, NSI connects distributors to products, services, and technologies by providing a fresh perspective and caring approach that drives smart solutions. The driving force behind a stable of market-leading brands and a large breadth of products, the company’s primary job for more than 45 years has been to fulfill the needs of distributors and their customers. By staying grounded in the principles of service and value, NSI continues to deliver high-quality, industry-advancing, and comprehensive product solutions that enable growth. NSI has many well-respected brands, including Bridgeport Fittings®, Polaris® Power Connectors, TORK® Timers and Controls, WarriorWrap® Professional Tape, TERMINATOR™ Premium Wire Connectors, RHINO Safety™, Platinum Tools®, TechLogix Network, Duro Dyne® Sheet Metal Accessories, Metallics™ Fasteners, Remke Industries, Lynn Electronics, and SUPCO. For additional information about NSI Industries and our family of brands, visit www.nsiindustries.com.



The Heavy Duty Nonmetallic CABLE RACK

For Power and Communications Manholes And Vaults

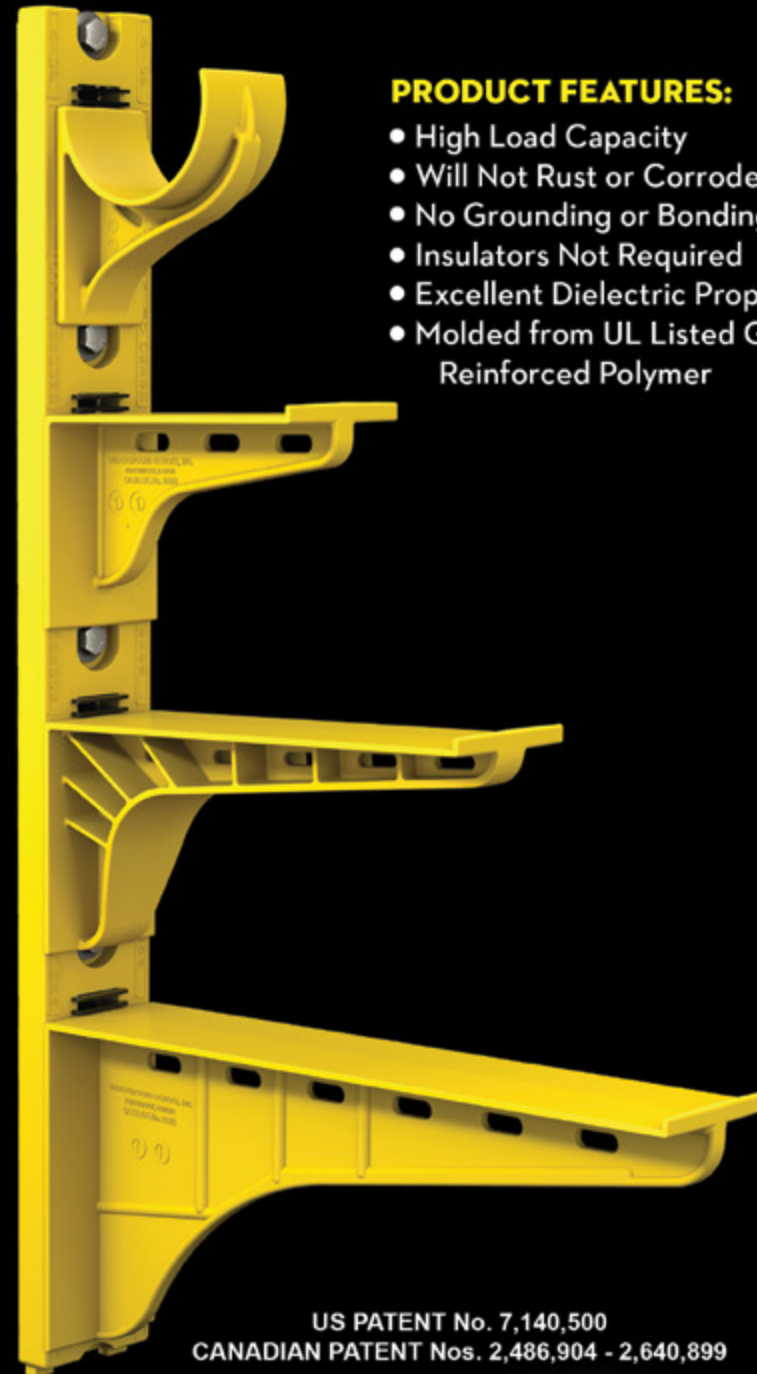

PRODUCT FEATURES:

- High Load Capacity
- Will Not Rust or Corrode
- No Grounding or Bonding
- Insulators Not Required
- Excellent Dielectric Properties
- Molded from UL Listed Glass Reinforced Polymer



HDL Arm Lock shown with RA04 Arm and CR36-B Stanchion



3HDS - 3" throat saddle shown with a cable secured by cable ties.



RA08 - 8" arm shown with three cables secured by cable ties.

US PATENT No. 7,140,500
CANADIAN PATENT Nos. 2,486,904 - 2,640,899

UNDERGROUND DEVICES
INCORPORATED



420 ACADEMY DRIVE
NORTHBROOK, IL 60062
Phone: 847-205-9000 • Fax: 847-205-9004
Website: www.udevices.com



Transition Couplings

PVC Bell End Adapter

Galvanized Rigid Conduit

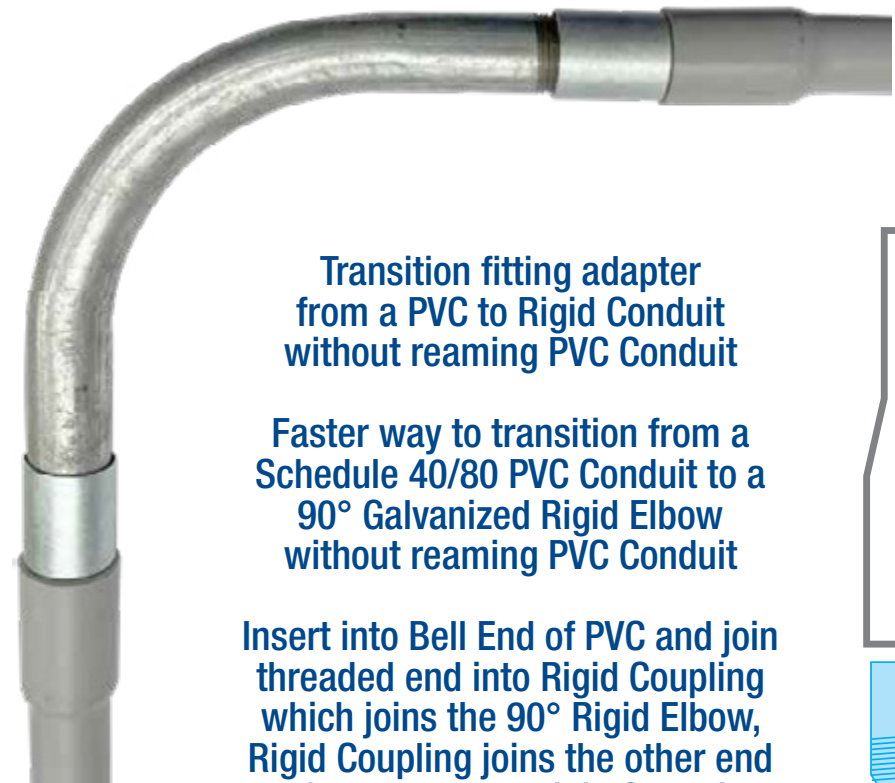

UL US
 PATENT PENDING

Transition fitting adapter
 from a PVC to Rigid Conduit
 without reaming PVC Conduit

Faster way to transition from a
 Schedule 40/80 PVC Conduit to a
 90° Galvanized Rigid Elbow
 without reaming PVC Conduit

Insert into Bell End of PVC and join
 threaded end into Rigid Coupling
 which joins the 90° Rigid Elbow,
 Rigid Coupling joins the other end
 of 90° Elbow to Rigid Conduit

Meets UL651 CSA CSS.L Ng83
 and US Army Corps or
 Engineers Specs.

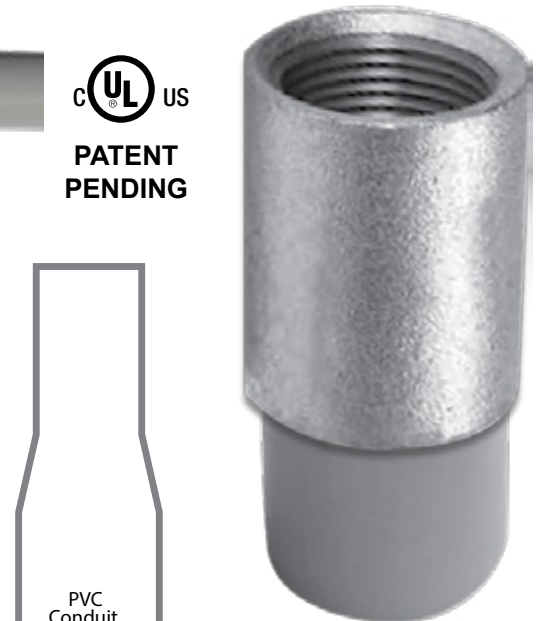

1/2" thru 6"

Transition Couplings

Size	Catalog #
1/2"	PBEA/RGD 50
3/4"	PBEA/RGD 75
1"	PBEA/RGD 100
1-1/4"	PBEA/RGD 125
1 1/2"	PBEA/RGD 150
2"	PBEA/RGD 200
2-1/2"	PBEA/RGD 250
3"	PBEA/RGD 300
3-1/2"	PBEA/RGD 350
4"	PBEA/RGD 400
5"	PBEA/RGD 500
6"	PBEA/RGD 600

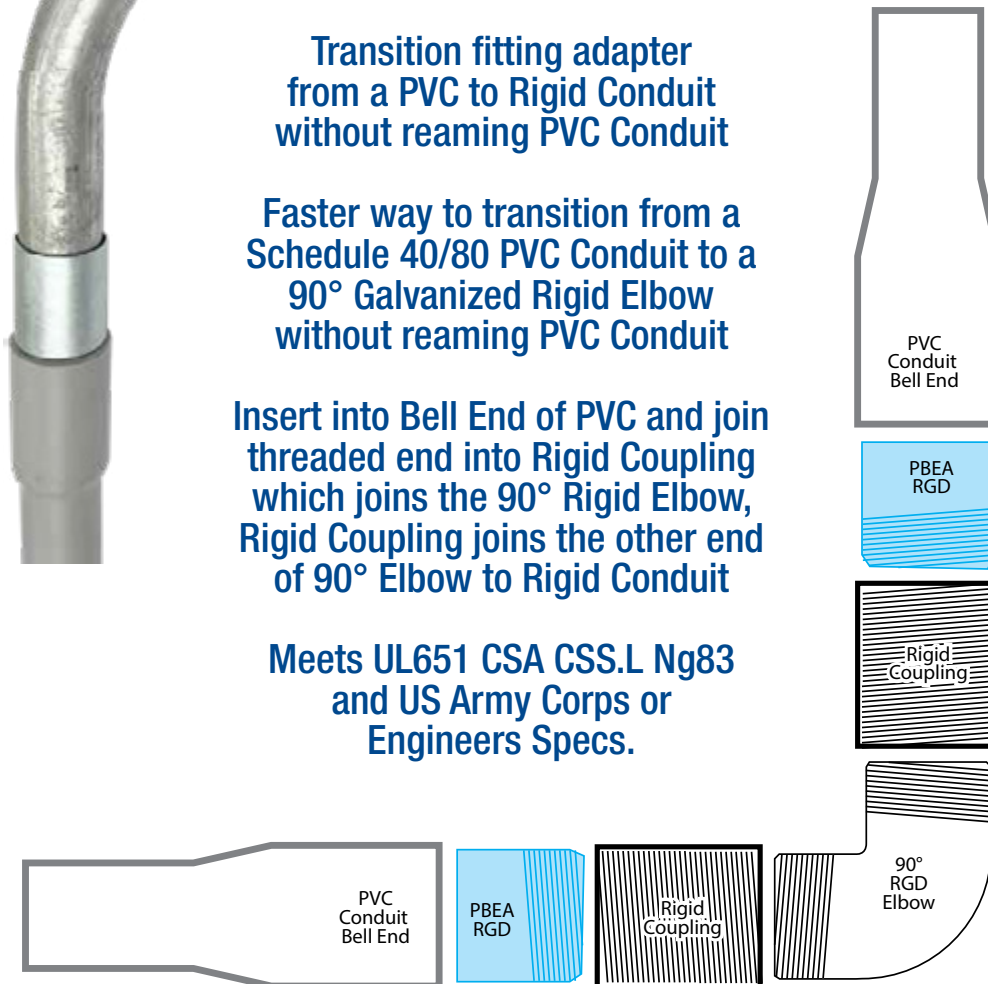

2022 NECA
Show Stopper
 WINNER

Customer must satisfy all codes and owners' specifications.



PATENT PENDING
 PATENTED



LABELS APPLY TO PRODUCTS ONLY WHERE SHOWN ABOVE

Electri-Flex Company Provides Community Meals for Thanksgiving

ELECTRI-FLEX COMPANY, Roselle, IL, celebrated Thanksgiving this year with its 3rd consecutive annual food drive, teaming with community leaders to deliver 800 meals this Thanksgiving holiday.

Sheriff James Mendrick, one of the Company's long-standing partners in helping with community efforts, discussed the impact this has had on the community. "What Electri-Flex started with the Sheriff's office has blossomed over a 3-1/2-year period, from 'come on down we have free food', to great organization, reaching a huge amount of people in need while partnering with local food pantries and food banks. It has been a pleasure working with community members that care enough to put in their resources and time."

Electri-Flex organized 800 meals complete with turkeys in their roasting pans, cans of corn and cranberries, boxes of stuffing and mashed potatoes, and much more. Electri-Flex employees and community leaders provided even more food, which was all boxed and distributed to the public in meal boxes right before the holiday weekend. Sponsors include Electri-Flex Company, the Roselle Police Association Foundation, the DuPage County Sheriff's Office, Lisle Township, Fates, Bodily & Parker PLLC, Precision Stamping Products, Meals on Wheels of DuPage County and SCARCE.

Sheriff Mendrick ended by saying, "It's a tribute to someone like Jason Kinander, who's a business owner and citizen of DuPage County, and he's helping all the people around him. There are people who talk about helping, and then there are people that directly help,



"What Electri-Flex started with the Sheriff's office has blossomed over a 3-1/2-year period, from 'come on down we have free food', to great organization, reaching a huge amount of people in need while partnering with local food pantries and food banks."

—Sheriff James Mendrick

and the Kinander family and the Electri-Flex employees directly help."

Electri-Flex Company, a leader in electrical conduit design and manufacture for over 65 years, produces Liquatite®, the most diverse line of

liquidtight flexible electrical conduit in the industry. The company offers custom design, engineering, quality assurance and testing capabilities.

For more information visit us online at www.electriflex.com. □

ABOUT ELECTRI-FLEX COMPANY

Electri-Flex Company, a leader in electrical conduit design and manufacture for over 65 years, produces Liquatite®, the most diverse line of liquidtight flexible electrical conduit in the industry. The company offers custom design, engineering, quality assurance and testing capabilities. For more information on Electri-Flex Company, call (630) 529-2920 or (800) 323-6174; fax: (630) 529-0482; e-mail: mktg@electriflex.com; visit: www.electriflex.com; or write: 222 West Central Avenue, Roselle, IL, 60172-1994.



"When Disasters Strike, First Responders Rely On Us!"

Our complete control, communication and convenience Utility Truck Console is becoming the new standard for truck fleets of all sizes. Loaded with standard and optional features that maximize ergonomics, productivity, and fleet/telecom standards into a one exceptional Mobile Console Solution.



MOBILE DESK
MOBILE OFFICE SOLUTIONS
1-877-663-3375
www.mobiledesk.com

Copyright © 2022 Mobile Desk, LLC. All Rights Reserved.

MONITOR ANY POWER SOURCE OR LOAD

VERIFYING BACKUP POWER
LOAD STUDIES
COST & ENERGY ANALYSIS
MEDIUM VOLTAGE MOTORS
POWER QUALITY
COMMISSIONING
HARMONIC DISTORTION
PREDICTIVE MAINTENANCE
DC POWER TESTING
400HZ MONITORING
AND MUCH MORE



COMPACT - CAPABLE - VERSATILE POWER ANALYZERS

IT'S ALL WE DO.

BUY • RENT • TRADE IN



The World's Only
Medium Voltage
Direct Connect
Solution

Made in USA
with US &
Imported Parts

Products in Stock!

Most Orders Ship
in 1-2 Days!

First there was 4 square...
and now the **REVOLUTIONARY 5 Square® Box!!**

You've struggled with 4 Square boxes for years - you know how small, cramped and time consuming they are. Finally, there is a solution that allows you the space you have always needed.

The **5 Square®** Boxes (5" x 5" x 2-7/8") provide up to 88 in³ of interior volume which more than doubles that of most existing boxes on the market.

Create a robust and unrivaled infrastructure for the life of your facility with the **5 Square®** Products!



Fire Signal



- TWICE THE VOLUME AS MOST BOXES
- SAVE LABOR...INCREASE PROFITS
- ELIMINATES TROUBLESHOOTING TIME AND COST
- FULLY UPGRADEABLE SYSTEM
- SPECIFIED BY ENGINEERING FIRMS, HOSPITALS, UNIVERSITIES & GOVERNMENT AGENCIES
- AVAILABLE IN ZINC OR RED

Telecommunications



- INTEGRAL CABLE MANAGEMENT
- SAVE LABOR...INCREASE PROFITS
- FACILITATES MIN. BEND RADIUS REQUIREMENTS
- SUPPORTS CURRENT AND EVOLVING SYSTEMS
- SUPPORTS PoE PLUS
- SPECIFIED BY ENGINEERING FIRMS, HOSPITALS, UNIVERSITIES & GOVERNMENT AGENCIES

advertiser
INDEX

This advertiser index is compiled as a courtesy to our readers. While every effort is made to provide a complete and accurate listing of companies and page numbers, the publisher is not responsible for errors. **Click the company name or page number to see their advertisement.**

Company	PG#	Company	PG#
AMERICAN CONDUIT	20	MOBILE DESK	29
APPLETON / EMERSON	13	POWERSIGHT / SUMMIT TECHNOLOGY	30
APPLETON / EMERSON	15	RANDL INDUSTRIES	31
CONDUIT REPAIR SYSTEMS	4	SOLAHD / EMERSON	17
EVLUMA	5	SOLAHD / EMERSON	21
EVLUMA	23	SP PRODUCTS INC	3
GREAVES USA	IBC	SP PRODUCTS INC	19
ITOOLco	IFC	SP PRODUCTS INC	26, 27
KRENZ & COMPANY	32	SP PRODUCTS INC	BC
MILLER SAFETY CONSULTANTS, LTD	7	TCP	1
MOBILE DESK	11	UNDERGROUND DEVICES	25

When it comes to transformer cooling fans, Krenz-Vent is the industry recognized gold standard. Our leadership position is earned through 80+ years of R&D plus our superior engineering and customer service. You can rest easy when you specify Krenz fans.

ENGINEERED TO COOL
There is no comparison.



KRENZ & COMPANY, INC.
KRENZVENT.COM • 262.255.2310 • KRENZ@KRENZVENT.COM

Happy Holidays

from the Staff of

Electrical Products & Solutions
The Purchasing Guide for Electrical Contractors



Making perfect connections has never been simpler. In fact, now it's a **SNAP!**

NEW SNAP Connectors from Greaves. A revolutionary compression connector concept that gets the job done with just a few turns of a standard wrench!

- ▶ Time-saving, easy installation
- ▶ Superior pull-out strength and conductivity
- ▶ No bulky and costly tools and dies



GREAVES

860-664-4505 | 800-243-1130 | www.greaves-usa.com | info@greaves-usa.com

SPPRODUCTS, INC.

Productivity and value thru ideas
FOR SAFER BETTER FASTER JOBS



We're Proud to be the Electricians' Friend for Over 50 Years!

IP5

"The Original"

Enter Any KO on Both Sides of the Box

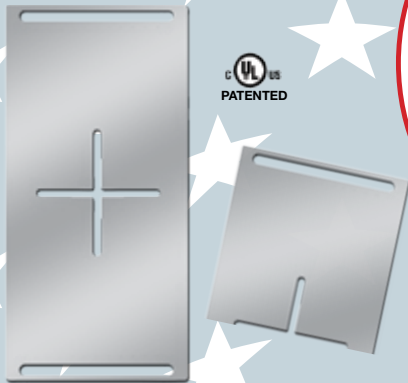

IP19/20
4-Conduit Block
PATENTED

IP21a
QwikBlock
PATENT PENDING

Use 4-Conduit Block (IP19 or IP20) with QwikBlock (IP21a)

IP6d

2-Way with Split Fingers for Horizontal or Vertical Installation

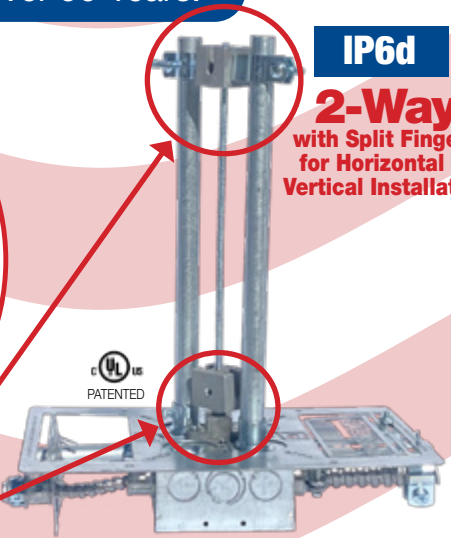

Our Family of Conduit & Box Support Plates Saves Valuable Time & Money!

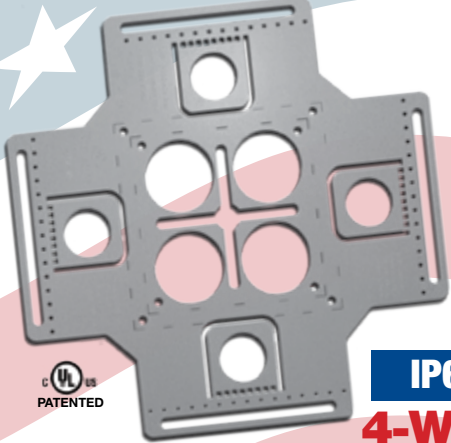

IP6
4-Way

Enter Any KO on All 4 Sides of the Box Plus 4 Large Open KOs in Center Allows Entering Back of Box

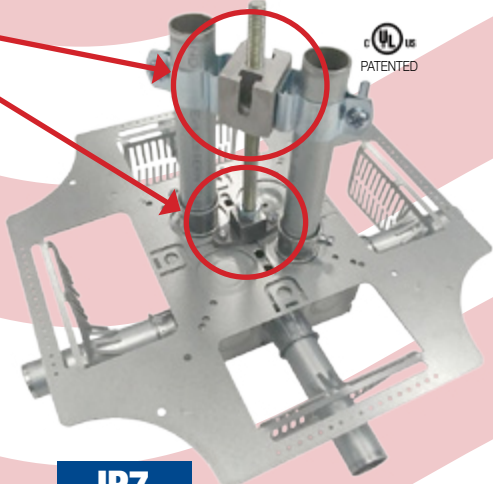

IP7

4-Way

with Split Fingers for Horizontal or Vertical Installation. Enter Any KO on All 4 Sides of the Box Plus 4 Large Open KOs in Center Allows Entering Back of Box.

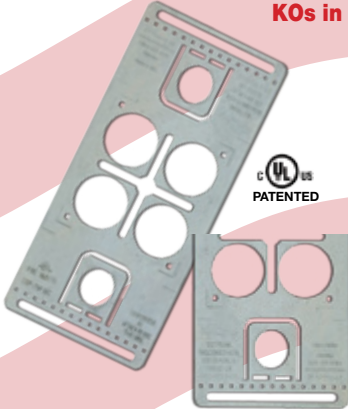

IP6a

2-Way/Half

Enter Any KO on 1 or 2 Sides of the Box Plus Large Open KOs in Center Allows Entering Back of Box

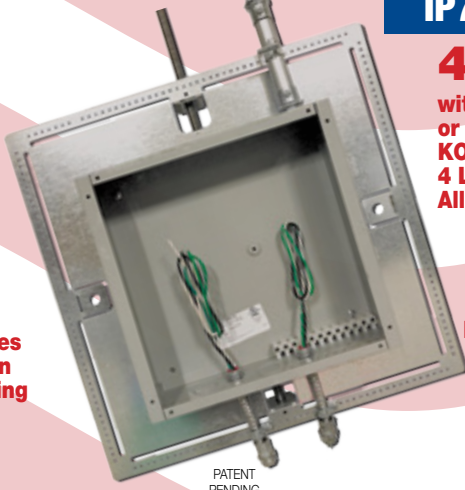

IP8

Mount Horizontally or Vertically from One Single Support

20 x 20

Supports up to 12 x 12 J-Box

28 x 28

Supports up to 20 x 20 J-Box

MADE IN THE USA!

Plus More Being Invented for *SAFER BETTER FASTER* Jobs . . . Call With Your Ideas!

SPProducts.com **800-233-8595** info@SPProducts.com